

VANK

CUBE

BIODESIGN FOR THE CHANGING AND CREATIVE
WORKPLACE OF THE FUTURE



VANK_CUBE IS A MODULAR **SYSTEM OF CUBES MADE OF FLAX AND HEMP BIOMATERIAL** THAT MAKES IT POSSIBLE TO SET UP AN ECO-FRIENDLY WORKSPACE FOR ANY SIZE AND PURPOSE – AND REARRANGE IT EASILY. IT ALSO BRINGS THE EVER IN-DEMAND FLEXIBILITY TO CO-WORKING SPACES, EVENT AND TRADE SHOW VENUES, START-UPS, CAFÉS OR EDUCATIONAL INSTITUTIONS WHEN

INTERIOR CUSTOMISABILITY COMES INTO PLAY. THANKS TO THE NATURAL MATERIAL AND COLOUR SCHEME, IT WILL BE A GREAT CHOICE FOR BOTH THOSE INTO MINIMALISM AND INTO JAPANDI OR BOHO.

DESIGN: ANNA VONHAUSEN



VANK_CUBE



VANK_CUBE HAS BEEN AWARDED A SPECIAL MENTION IN THE EXCELLENCE IN BUSINESS TO BUSINESS – OFFICE SOLUTIONS CATEGORY IN **THE GERMAN INNOVATION AWARD 2023** COMPETITION.

CIRCULAR DESIGN FOR CLIMATE NEUTRALITY



VANK_CUBE ADDRESSES THE EXPECTATIONS OF NEW GENERATIONS, WHO VALUE OFFICES BEING DESIGNED AND FURNISHED WITH CONCERN FOR THE **ENVIRONMENT AND WITH REDUCED CO2 EMISSIONS** IN MIND. THIS IS CONSISTENT WITH THE INDIVIDUAL VALUES THAT THE NEW GENERATION CONSIDERS IMPORTANT, AND IS ONE OF THE MAIN NON-WAGE FACTORS FOR YOUNG JOBSEEKERS.

VANK_CUBE UNITS ARE MANUFACTURED WITH THE APPLICATION OF MODERN TECHNOLOGY MAKING USE OF A BIOCOMPOSITE BASED ON SOFT FLAX AND HEMP FIBRES. THESE PLANTS ABSORB CO₂ FROM THE ATMOSPHERE DURING THEIR GROWTH PHASE AND CONVERT IT INTO BIOMASS THROUGH PHOTOSYNTHESIS. VANK_CUBE IS THEREFORE A PRODUCT **WITH A MUCH SMALLER**



CARBON FOOTPRINT THAN OTHER STORAGE SYSTEMS OR TYPICAL OFFICE FURNITURE. IN ADDITION, IT IS BASED ON **FAST-GROWING FIBROUS PLANTS THAT ARE ANNUALLY RENEWABLE**, DO NOT REQUIRE IRRIGATION OR FERTILISATION, AND ARE SAFE AND HUMAN-FRIENDLY DUE TO THEIR NATURAL ORIGIN. THUS, IT IS A COLLECTION DESIGNED IN ACCORDANCE WITH THE PRINCIPLES

OF SUSTAINABLE GROWTH, CONTRIBUTING TO THE DEVELOPMENT OF THE CIRCULAR ECONOMY AND THE USE OF RENEWABLE BIO-RESOURCES.

BUILDING IS FOR EVERYONE



MODULARITY MEANS THAT A NUMBER OF VANK_CUBES PUT TOGETHER CAN BE USED AS **A DESK, A WORKSHOP MEETING TABLE, A FRONT DESK, A STORAGE UNIT, A LECTERN, A CONTAINER, A SHELF FOR HOUSEHOLD APPLIANCES, OR A SPACE-DIVIDING UNIT**. THANKS TO THE FLEXIBLE 'BUILDING BLOCK' AND A SET OF DEDICATED CONNECTORS AND FASTENERS, IT IS POSSIBLE TO CREATE

MANY DIFFERENT FURNITURE FORMS AND MODIFY THEM AS NECESSARY VIRTUALLY WITHOUT LIMITS. IT TAKES ONLY A FEW MOMENTS TO TRANSFORM A SET OF DESKS INTO AN EVENT SETTING: A MEETING AREA WITH SEATS, A FRONT DESK, A BAR, OR A PROJECT SPACE WITH HIGH MEETING TABLES, A LECTERN, AND SHELVING UNITS.



BE INSPIRED BY THE
POSSIBILITIES FOR CHANGE
AND CONFIGURATIONS

SEE THE ANIMATION >



AN AGILE ANSWER TO THE TEMPORARY NATURE OF TEAMS



THE POSSIBILITY OF FURNISHING AN OFFICE THE **AGILE** WAY, IN LINE WITH THE "OFFICE EVERYWHERE" CONCEPT, BECAME ESPECIALLY IMPORTANT DURING THE HEALTH CRISIS AND HAS SINCE REMAINED A MAINSTAY OF THE HYBRID WORK MODEL. IT AIMS TO CREATE A FLEXIBLE AND USER-FRIENDLY WORKSPACE THAT FOSTERS **CREATIVITY, COLLABORATION, AND EMPLOYEE WELL-BEING.**

THE SYSTEM, BASED ON A LIGHTWEIGHT CUBE MADE OF BIOMATERIAL, OFFERS THE OPPORTUNITY TO EASILY ARRANGE OFFICES AND CO-WORKING SPACES ACCORDING TO **THE CHANGING NEEDS** OF NOT ONLY THE USER, BUT ALSO THE ENTIRE ORGANISATION. THIS FEATURE IS PARTICULARLY IMPORTANT WHEN THE SIZE OF THE LEASED SPACE, THE NUMBER OF EMPLOYEES AND CLIENTS,



THE FUNCTIONS OF INDIVIDUAL ROOMS, AND THE GENERAL ARRANGEMENT OF THE OFFICE CHANGE FREQUENTLY. INCORPORATING THE SYSTEM INTO WELL-ESTABLISHED AND RIGIDLY STRUCTURED COMPANIES MAKES IT POSSIBLE TO BREAK DOWN HIERARCHIES AND BLUR THE LINES BETWEEN INDIVIDUAL DEPARTMENTS.

THE **EASY ASSEMBLY AND DISASSEMBLY** MEANS THE POSSIBILITY TO SET UP TEMPORARY OFFICES OR EXHIBITION SPACES AT TRADE SHOWS, CONFERENCES, AND WORKSHOPS.

FRESH IDEAS AND RIPE FRUITS OF COLLABORATION



THE DESIGN SUPPORTS
CREATIVE TEAMS,

SOCIAL INTERACTION, THE ART OF IMPROVISATION,
AND THE CULTURE OF COLLABORATION, BUT ALSO LETS
INDIVIDUALISTS WORKING REMOTELY DO THEIR JOB IN
A FUN ENVIRONMENT – IT'S COMPACT AND LIGHTWEIGHT
HOME OFFICE EQUIPMENT.



VANK_CUBE

THE INFINITE NUMBER OF MODULE FUNCTIONS
TRANSLATES INTO VIBRANT, FANCIFUL SPACES THAT
RESEMBLE A PLAYROOM AND ENCOURAGE DYNAMIC
PROBLEM SOLVING.

MODULARITY

ADAPTABILITY TO CHANGING NEEDS IS OF THE ESSENCE



STORAGE FUNCTION

VANK_CUBE OFFERS A VERY USEFUL **STORAGE FUNCTION** – THE USER CAN DECIDE WHETHER TO EXPOSE OR COVER THE ITEMS KEPT ON THE SHELF BY CHANGING THE DIRECTION IN WHICH THE CUBE FACES OR BY USING ADDITIONAL PANELS THAT ALSO SERVE TO STABILISE THE SEAT.



NARROW, LIGHTWEIGHT TOPS WITH DEPTHS TO MATCH THE DIMENSIONS OF A SINGLE VANK_CUBE UNIT ARE MADE OF HARDWOOD PLYWOOD WITH OAK VENEER AND

OPTIONALLY COATED WITH WATER-BASED VARNISH IN GREEN, ORANGE OR VIOLET.

CASE STUDY



ARUP

ARUP'S OFFICE IN WARSAW IS AN EXEMPLARY MODEL OF HOW A WORKSPACE CAN BE BOTH FRIENDLY TO THE ENVIRONMENT AND PEOPLE. THE PROJECT INCLUDED VANK_CUBE, WHICH CAN CHANGE ITS FORMS BOTH INSIDE AND OUTSIDE THE WORKSHOP ROOM.



INTERIOR DESIGN: WORKPLACE
PROJECT COORDINATION: ZERO WASTE DESIGN
PHOTOGRAPHY: ADAM GRZESIK
YEAR OF THE PROJECT: 2023

EXAMPLES OF CONFIGURATIONS





INTERIOR DESIGNERS AND **USERS CAN**
CREATE NEW FORMS AND TURN EXISTING
FURNITURE INTO ORIGINAL, IMAGINATIVE
COMPOSITIONS.



VANK_CUBE



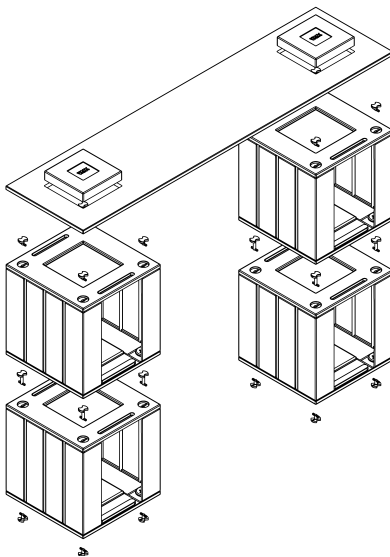

INTERIOR DESIGNERS AND USERS CAN CREATE NEW FORMS AND TURN EXISTING FURNITURE INTO ORIGINAL, IMAGINATIVE COMPOSITIONS. THIS IS MADE POSSIBLE THANKS TO THE MULTITUDE OF **ELEMENTS THAT COMPLEMENT THE CUBE**, INCLUDING TOPS, FASTENERS AND CONNECTORS, SIDE PANELS, AND PLATES MADE OF VANK_BIO BIOMATERIAL, A BASE WITH CASTORS OR AN UPHOLSTERED SEAT CUSHION.

DOWNLOAD ASSEMBLY MANUAL >





VANKLEUCUBE

SYSTEM COMPONENTS



CB36

dimensions	
height	36
depth	36
width	36



CB-W

dimensions	
height	35.5
depth	1.8
width	19



CB-C

dimensions	
height	3.5
depth	18
width	18



CB-J

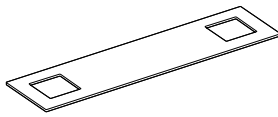

CB-T

dimensions	
height	1.5
depth	36
width	144



CB-TS

dimensions	
height	2.5
depth	36
width	36

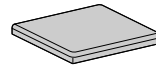

CB-P

dimensions	
height	5
depth	36
width	36

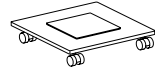

CB-M

dimensions	
height	6
depth	36
width	36

**CONFIGURE
IN PCON**



COFFEE, SIDE, AND BED TABLE



CB-TAB

dimensions	
height	37,5
depth	36
width	36

POUFS

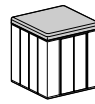

CB-SEAT

dimensions	
height	41
depth	36
width	36

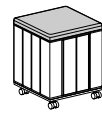

CB-SEAT-M

dimensions	
height	47
depth	36
width	36

STORAGE AND SIDEBOARDS

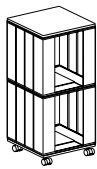

CB-CONT

dimensions	
height	79,5
depth	36
width	36

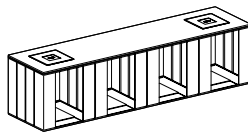

CB-SHELV-1

dimensions	
height	38
depth	36
width	144

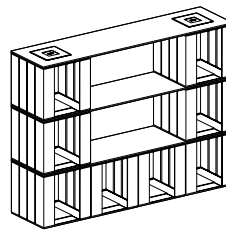

CB-SHELV-3

dimensions	
height	114
depth	36
width	144

DESKS AND TABLES

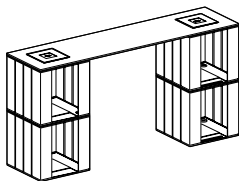

CB-DESK

dimensions	
height	74
depth	36
width	144

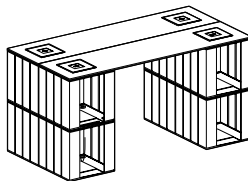

CB-DESK-2

dimensions	
height	74
depth	72
width	144

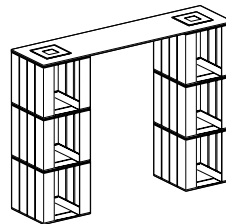

CB-DESK-H

dimensions	
height	110
depth	36
width	144

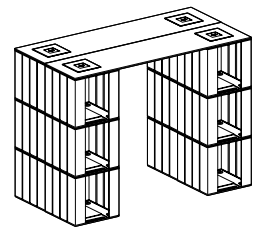

CB-DESK-2H

dimensions	
height	110
depth	72
width	144

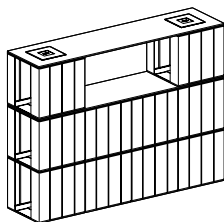

CB-COUNTER

dimensions	
height	112
depth	36
width	144

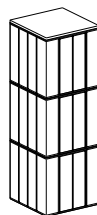

CB-LEC

dimensions	
height	109,5
depth	36
width	36

MATERIALS



BEIGE AND BROWN CUBES BRING A NATURAL LOOK TO THE INTERIORS. VANK_BIO MATERIAL EMPHASISES THE IMPERFECTION OF NATURE AND ITS UNIQUENESS CREATES A NEW VALUE FOR INTERIOR DESIGNERS

AND ARCHITECTS. MATT TEXTURES AND ROUGHNESS INSPIRE MORE TRUST TODAY THAN THE PERFECT, SHINY, SMOOTH SURFACES OF SYNTHETICS.

FABRICS

WELL



GRANOLA

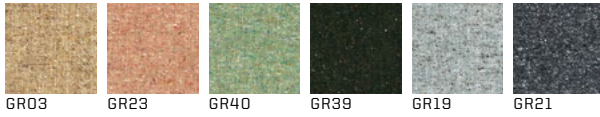

SYNERGY



VANK_CUBE

WOOD

TOP



WHAT THE VANK!

VANK IS A POLISH TEAM OF ARCHITECTS,
CREATIVES, ENGINEERS, AND ARTISANS.
WE CREATE FURNITURE. OBJECTS. TANGIBLE SIGNS
IN SPACE. ITEMS DESIGNED INTELLIGENTLY, WITH
RESPECT FOR THE NATURAL ENVIRONMENT, AND
MANUFACTURED USING LATEST TECHNOLOGIES.

WE BELIEVE IN A CIRCULAR ECONOMY MODEL THAT
LIMITS THE CONSUMPTION OF NATURAL RESOURCES,
REDUCES THE AMOUNT OF WASTE GENERATED,
AND INCREASES THE USE OF BIODEGRADABLE,
RENEWABLE, AND RECYCLABLE MATERIALS.
WE WANT OUR FURNITURE TO IMPROVE THE
AESTHETICS OF THEIR SURROUNDINGS.
TO BE PRESENT AND SEEN WHILE MAINTAINING
THE RIGHT BALANCE BETWEEN FUNCTION AND
VISUAL APPEAL. WE'RE ALL ABOUT HIGH QUALITY,
TAKING RESPONSIBILITY FOR WHAT WE DO AND
MAKE, AND MAKING OUR PRODUCTS LAST
AS LONG AS POSSIBLE.



SEE MORE:

WWW.VANK.DESIGN

