



VANK

V6

ENERGISE YOUR OFFICE
FORCE MOTRICE POUR TRAVAILLER



ADMIRE THE UNIQUE SHAPE. THE ALUMINIUM ELEMENTS.
VANK HAVE ENGINEERED THEIR FIRST SWIVEL CHAIR.
VANK PRÉSENTE SON PREMIER FAUTEUIL PIVOTANT : D'UNE
FORME CARACTÉRISTIQUE, D'UN DESIGN INDUSTRIEL, EN
ALUMINIUM, PRODUIT LOCALEMENT.



VANK_V6



THE NEW SEAT OF POWER
ERGONOMIQUE







THE **VANK_V6** HAS BEEN DESIGNED AS A SOURCE OF ENERGY FOR WORK. THE AESTHETICS REFLECT SPORTS CAR DESIGN. THE ERGONOMICS ACCOMMODATE A WIDE RANGE OF USES AND USERS.

CONÇU POUR INCITER AU TRAVAIL, LE MODÈLE **VANK_V6** SE RÉFÈRE-T-IL AUX VOITURES DE SPORT, GRÂCE À SON ERGONOMIE RÉPOND AUX BESOINS DIVERS DES UTILISATEURS.

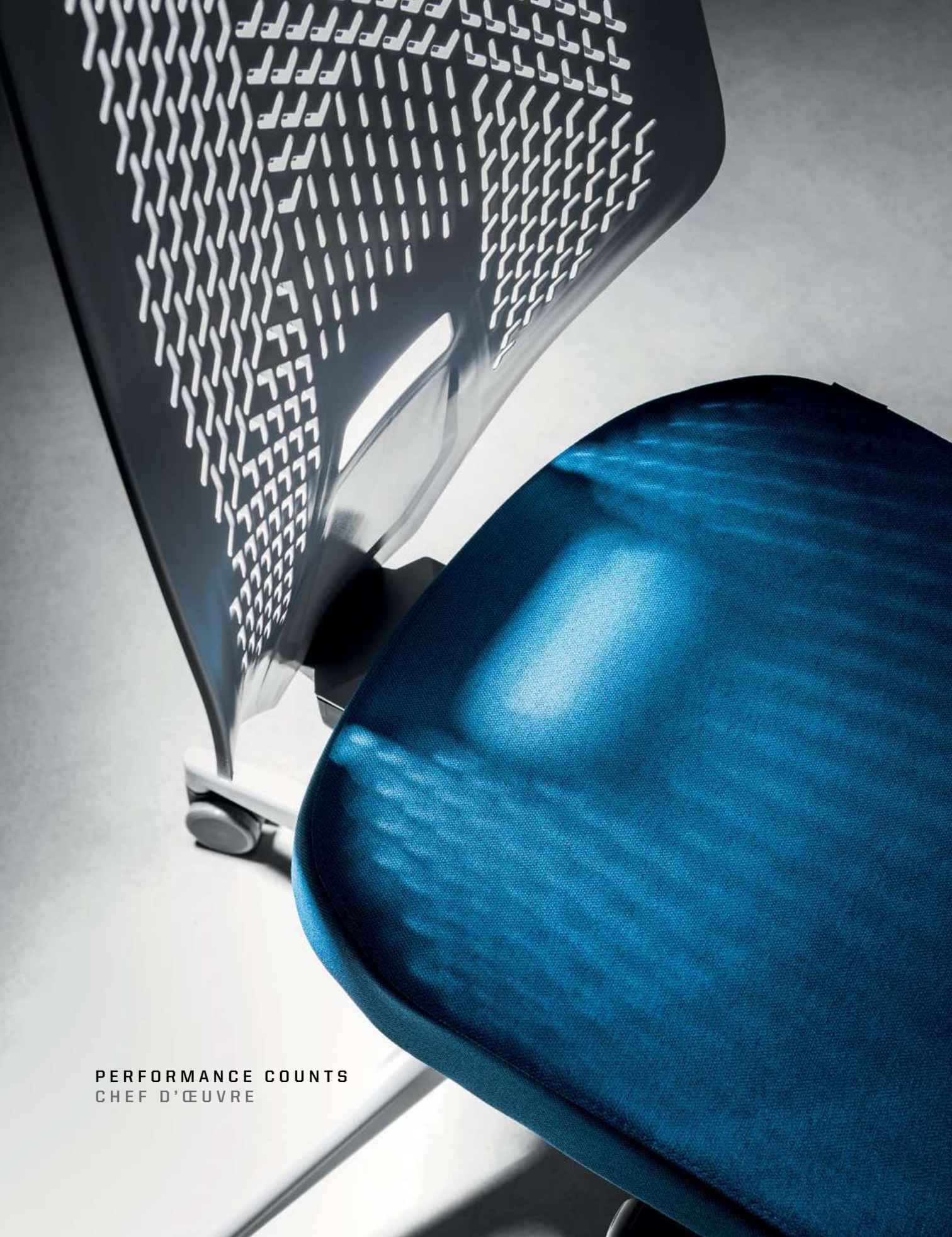
VANK_V6



PERFORMANCE COUNTS
CHEF D'ŒUVRE



THE DESIGN IS INSPIRED BY THE RHYTHM OF THE CITY, MODERN ARCHITECTURE AND DYNAMIC SPORTS CARS. THIS CHAIR IS NOT JUST ABOUT LOOKS, BUT ALSO ABOUT PERFORMANCE.

LA CONCEPTION DU FAUTEUIL EST INSPIRÉE PAR LE RYTHME DE LA VILLE, PAR SON ARCHITECTURE MODERNE, PAR LES VOITURES DYNAMIQUES À CARACTÈRE SPORTIF QUI FASCINENT NON PAS SEULEMENT PAR LEUR ALLURE MAIS AUSSI PAR LEURS PERFORMANCES.



THE **VANK_V6** HAS A STRIKING SHAPE AND STRONG ALUMINIUM ACCENTS. THE GEOMETRIC DESIGN AND TRANSPARENT BACK GIVE THE CHAIR A LIGHT FEELING.

LE FAUTEUIL A UNE FORME CARACTERISTIQUE, AVEC LES ÉLÉMENTS SOLIDES EN ALUMINIUM, GAGNE EN LÉGÈRETÉ GRÂCE AU DOSSIER TRANSLUCIDE AVEC LE MOTIF GÉOMÉTRIQUE.



VANK_V6





VANK_V6









VANK_V6

A close-up, high-contrast photograph of a dark, textured aluminium chassis component. The word "VANK" is embossed in a bold, sans-serif font on the upper portion of the part. Below the main body, there are several vertical, rectangular protrusions that appear to be part of a mounting or support structure. The lighting is dramatic, highlighting the metallic texture and sharp edges against a dark background.

VANK

ALUMINIUM CHASSIS
CHASSIS EN ALUMINIUM

THE ALUMINIUM USED TO MAKE THIS CHAIR IS **100% RECYCLED**. THIS IS NOT JUST ENVIRONMENTALLY FRIENDLY. IT ALSO GIVES THE CHAIR A TOUCH OF MAGIC.

LE FAUTEUIL EST PRODUIT EN ALUMINIUM PROVENANT EN **100% DU RECYCLAGE**. CECI EST UNE SOLUTION NON SEULEMENT ÉCOLOGIQUE MAIS AUSSI EN QUELQUE SORTE MAGIQUE.

VANK_V6





THE **VANK_V6** ARMCHAIR, USUALLY ENCOUNTERED IN OFFICE ENVIRONMENTS, WILL ALSO MAKE A GREAT ADDITION TO YOUR HOME INTERIORS. IT CAN BE USED FROM EARLY MORNING TO LATE NIGHT - FOR WORK, LEARNING, OR GAMING BECAUSE ITS MECHANICS HAVE BEEN DESIGNED WITH DIFFERENT NEEDS IN MIND. THE RANGE OF VANK_V6'S ERGONOMIC FEATURES AND CUSTOMISATION OPTIONS MAKES ITS USER BECOME LITERALLY ONE WITH THE CHAIR. THE ARMCHAIR IS AVAILABLE WITH UPHOLSTERED HEADREST, ADJUSTABLE IN HEIGHT AND ANGLE. THE BACKREST CAN BE FULLY UPHOLSTERED, ALSO AT THE BACK, GIVING IT A HOMELY FEEL.

LE FAUTEUIL **VANK_V6**, DÉJÀ BIEN CONNU DANS LE MILIEU DES BUREAUX, TROUVE PARFAITEMENT SA PLACE DANS LE CONFORT MAISON. IL PEUT ÊTRE UTILISÉ DU MATIN AU SOIR - POUR TRAVAILLER, ÉTUDIER OU JOUER - CAR IL COMPORTE UNE MÉCANIQUE INTUITIVE QUI PERMET D'ANTICIPER SUR DE DIFFÉRENTS BESOINS. SON ERGONOMIE ET SES LARGES CAPACITÉS D'ADAPTATION FONT QUE L'UTILISATEUR EN DEVIENT LITTÉRALEMENT PARTIE. LE FAUTEUIL EST DISPONIBLE AVEC UN APPUÏ-TÊTE REMBOURRÉ, ÉQUIPÉ EN RÉGLAGES DE L'ANGLE ET DE LA HAUTEUR. LE DOSSIER PEUT ÊTRE ENTIÈREMENT REMBOURRÉ, Y COMPRIS À L'ARRIÈRE, CE QUI LUI DONNE UN CARACTÈRE D'INTIMITÉ.



HOME OFFICE





A WIDE RANGE OF FABRICS AND COLOUR OPTIONS FOR THE ALUMINIUM ELEMENTS MEAN THAT YOU CAN CUSTOMISE YOUR CHAIR TO YOUR OWN TASTE.

UN CHOIX LARGE DE TISSUS ET DE COULEURS DES ÉLÉMENTS EN ALUMINIUM PERMET D'ADAPTER VANK_V6 À CHAQUE GOÛT.



POL (POLISHED)



BK (BLACK)



SI (SILVER)



GB (GOLD-BEIGE)



BR (BROWN)



VANK_V6



OR (ORANGE)



YL (YELLOW)



BL (BLUE)



GN (GREEN)



BACKREST, SEAT AND BASE OF
ARMRESTS IN BLACK, **T-BK**

LE DOSSIER, LE SUPPORT DE L'ASSISE
ET LES ACCOUDOIRS NOIRS **T-BK**



BACKREST, SEAT AND BASE OF
ARMRESTS IN SILVER, **T-GY**

LE DOSSIER, LE SUPPORT DE L'ASSISE
ET LES ACCOUDOIRS GRIS CLAIR **T-GY**



- ARMRESTS IN BLACK WITH **PLASTIC** BASES, **BK/N-BK**

LES ACCOUDOIRS NOIRS SUR LES SUPPORTS EN **PLASTIQUE BK/N-BK**.



- ARMRESTS IN BLACK WITH POLISHED **ALUMINIUM** BASES, **BK/N-BK**

LES ACCOUDOIRS NOIRS SUR LES SUPPORTS EN **ALUMINIUM POLI BK/N-BK**



- ARMRESTS IN LIGHT GREY WITH **PLASTIC** BASES, PADS AND ADJUSTER IN BLACK, **GY/N-BK**

LES ACCOUDOIRS GRIS CLAIR SUR LES SUPPORTS EN **PLASTIQUE**, COUVERTURE ET BOUTON-PRESSION NOIRS **GY/N-BK**.



- ARMRESTS IN LIGHT GREY WITH POLISHED **ALUMINIUM** BASES, PADS AND ADJUSTER IN BLACK, **GY/N-BK**

LES ACCOUDOIRS GRIS CLAIR SUR LES SUPPORTS EN **ALUMINIUM POLI**, COUVERTURE ET BOUTON-PRESSION NOIRS **GY/N-BK**



GY/N-PU

BK/N-PU

- ARMREST PADS MADE FROM POLYURETHANE FOAM, **N-PU** (OPTION)

LES COUVERTURES DES ACCOUDOIRS EN MOUSSE DE POLYURÉTHANE **N-PU** (AU CHOIX)



GY/N-GY

- ARMREST PADS IN LIGHT GREY, **N-GY** (OPTION)

LES COUVERTURES DES ACCOUDOIRS GRIS CLAIR **N-GY** (AU CHOIX)



SYNCHRONIZED MOVEMENT
OF THE SEAT AND THE BACKREST
RÉGLAGE DU DOSSIER ET ASSISE
SYNCHRONISÉ

30°
BACKREST INCLINATION
ANGLE ADJUSTMENT
RÉGLAGE D'INCLINAISON
DU DOSSIER
30 POSITIONS
À L'ARRIÈRE

5 POSITIONS TO LOCK THE BACKREST
IN ANTI-KICKBACK FUNCTION
5 POSITIONS DE BLOCAGE
D'INCLINAISON DU DOSSIER
FONCTION ANTICHOC

45 X 48cm

SHAPED SURFACE OF THE SEAT
SURFACE DE L'ASSISE PROFILÉE

FOAM SHAPE ELIMINATING
THE PRESSURE ON THE LEGS
LA MOUSSE PROFILÉE RÉDUIT
LA COMPRESSION DES
JAMBES

SEATING HEIGHT
ADJUSTMENT LUMBAR
SUPPORT HEIGHT
RÉGLAGE DE LA
HAUTEUR DU DOSSIER
SUPPORT LOMBAIRE

8 cm

17 - 25

96 - 115

40 - 52

12cm

SEATING HEIGHT ADJUSTMENT
RÉGLAGE DE LA HAUTEUR DU SIÈGE

V6 PARAMETERS

680

6cm

40 - 46

SEATING DEPTH
ADJUSTMENT
RÉGLAGE DE LA PROFONDEUR
DE L'ASSISE

45-120kg
BACKREST PRESSURE
ADJUST TABLE
RÉGLAGE DE LA PRESSION DU
DOSSIER EN FONCTION DU POIDS
DE L'UTILISATEUR

THE VANK_V6 CHAIRS COMPLY WITH
THE EN 1335-1, EN 1335-2, EN 1335-3
STANDARDS (TYPE A).

LES FAUTEUILS VANK_V6 SONT
CONFORMES AUX NORMES: EN 1335-1,
EN 1335-2, EN 1335-3 (TYP A).

+ 100

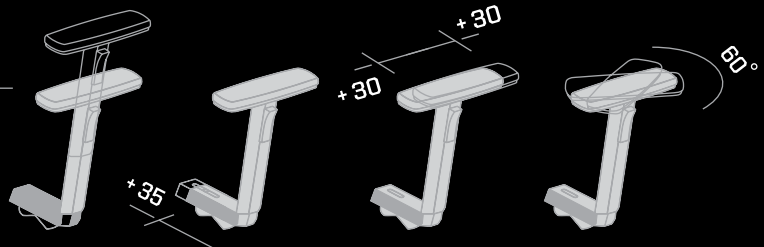

1 BACKREST
MADE FROM PLASTIC AND FIBREGLASS FOR FLEXIBILITY AND LONGEVITY, PERFECTLY ADAPTED TO THE NATURAL CURVATURE OF THE SPINE, TRANSPARENT PATTERN CONVEYS LIGHTNESS

LE DOSSIER
FAIT EN PLASTIQUE AVEC L'ADDITION DE LA FIBRE DE VERRE, AJUSTÉ À LA COURBURE VERTÉBRALE NATURELLE, AVEC UN MOTIF TRANSLUCIDE QUI LUI APPORTE DE LA LÉGÈRETÉ VISUELLE EN GARDANT EN MÊME TEMPS LA FLEXIBILITÉ ET SOLIDITÉ.

WATCH THE VIDEO >



2 SEAT
THE SADDLE-SHAPED FOAM IN DIFFERENT THICKNESSES ADAPTS TO THE SHAPE OF THE BODY, INCREASING COMFORT, ENSURING AN UPRIGHT PELVIS AND SUPPORTING THE LEGS WITH A 5-DEGREE FORWARD LEAN

L'ASSISE
LE COUSSIN D'UNE ÉPAISSEUR CHANGEABLE SOUS FORME DE SELLE, REFLÈTE LE POSITIONNEMENT ANATOMIQUE DU CORPS, AUGMENTE LE CONFORT DANS LA POSITION ASSISE, GARANTIT UN BON POSITIONNEMENT DU BASSIN, SOUTIÈNE CORRECTEMENT LES CUISSES AVEC L'INCLINAISON À L'AVANT DE 5 DEGRÉS.

3 4D ARMRESTS
ADJUSTABLE IN HEIGHT, DEPTH, WIDTH AND LEAN. ON ALUMINIUM OR PLASTIC SUPPORTS

LES ACCOUDOIRS 4D
AVEC LA POSSIBILITÉ DE RÉGLER AUSSI BIEN LA HAUTEUR, QUE LA PROFONDEUR, POSÉS SUR LES SUPPORTS EN ALUMINIUM OU EN PLASTIQUE.

4 BACKREST BASE
MADE OF SOLID ALUMINIUM, WITH HEIGHT ADJUSTMENT FOR PEOPLE MEASURING FROM 150 TO 200 CM (4'11" - 6'7")

LE SUPPORT DU DOSSIER
MONOCOQUE, EN ALUMINIUM, AVEC LA POSSIBILITÉ DE RÉGLER LA HAUTEUR DU DOSSIER, ADRESSÉ AUX UTILISATEURS D'UNE TAILLE DE 150-200 CM.

5 CROSS BASE
5-SPOKE BASE 5-SPOKE CAST ALUMINIUM FRAME FOR SAFETY AND DURABILITY

LE PIÈTEMENT
LA BASE À 5 BRANCHES, EN ALUMINIUM COULÉ SOUS PRESSION, POUR GARANTIR LA SÉCURITÉ DE L'USAGE ET FERMÉTÉ.

6 WHEELS
FOR DIFFERENT FLOOR TYPES FOR CARPET OR HARD FLOORS (RW), OPEN ROLLERS (OHR/ORW) OR CLOSED ROLLERS WITH CHROME RING (CRH/CRW)

LES ROULETTES
ADAPTÉES À TOUTS LES TYPES DE SOLS : MOQUETTE, SOLS DURS (RW), LES ROULETTES OUVERTES (OHR/ORW) DANS L'OPTION OU BIEN LES ROULETTES ANNEAU CHROMÉ (CRH/CRW).



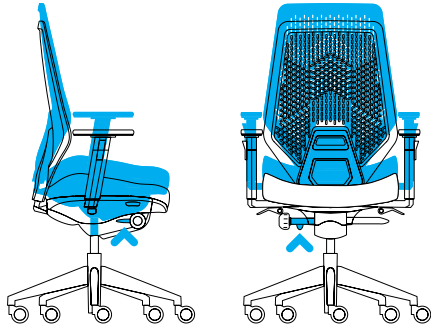

1 SEAT HEIGHT ADJUSTMENT: 40-52 CM

RÉGLAGE DE LA HAUTEUR DU SIÈGE ENTRE 40 ET 52 CM

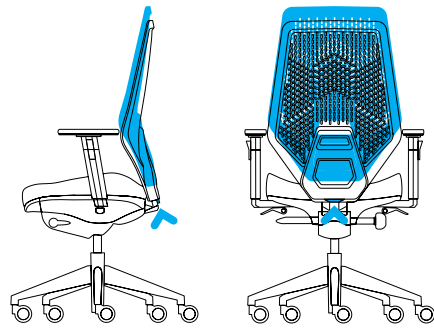

2 HEIGHT ADJUSTMENT OF THE BACKREST: 11 POSITIONS IN A 8 CM RANGE

RÉGLAGE DE LA HAUTEUR DU DOSSIER ENTRE 8CM

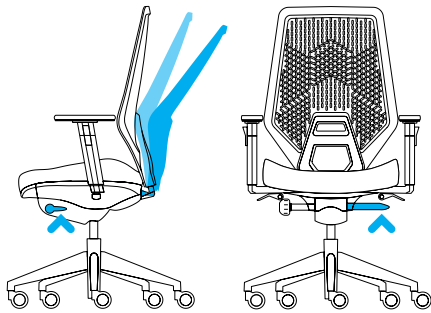

3 ADJUSTMENT OF BACKREST ANGLE WITH 5 LOCK POSITIONS

RÉGLAGE DE L'ANGLE D'INCLINAISON DU DOSSIER ET 5 POSITIONS DE BLOCAGE

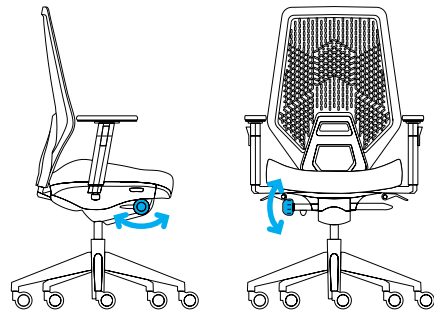

4 BACKREST BACK PRESSURE SETTING WITH A WIDE ADJUSTMENT SCALE

LE MÉCANISME D'ADAPTATION DE LA PRESSION DU DOSSIER AVEC UNE ÉCHELLE DE RÉGLAGE EXTRÊMEMENT LARGE

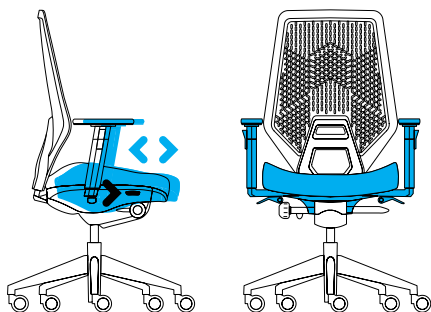

5 SEAT DEPTH ADJUSTMENT: 5 POSITIONS IN A 6 CM RANGE

RÉGLAGE DE LA PROFONDEUR DE L'ASSISE DE 6 CM ET 5 POSITIONS DE BLOCAGE POSSIBLES

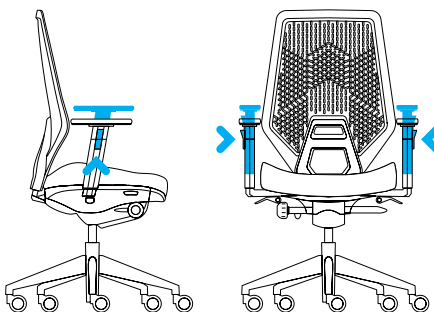

6 ADJUSTMENT OF 4D ARMRESTS: HEIGHT, DEPTH, WIDTH AND LEAN

LES ACCOUDOIRS 4D AVEC LA POSSIBILITÉ DE RÉGLER LA HAUTEUR, LA PROFONDEUR, LA LARGEUR ET L'ANGLE





V6 600020

dimensions	seats	overall
height	40-52	95-115
depth	40-46	68
width	48	68



V6 600022

wymiar	seats	overall
wysokość	40-52	95-115
głębokość	40-46	68
szerokość	48	68



V6 601020

dimensions	seats	overall
height	40-52	95-115
depth	40-46	68
width	48	68



V6 601022

dimensions	seats	overall
height	40-52	95-115
depth	40-46	68
width	48	68



V6 601050

dimensions	seats	overall
height	40-52	95-115
depth	40-46	68
width	48	68



V6 603020

dimensions	seats	overall
height	40-52	95-115
depth	40-46	68
width	48	68



V6 603022

dimensions	seats	overall
height	40-52	95-115
depth	40-46	68
width	48	68



V6 603050

dimensions	seats	overall
height	40-52	95-115
depth	40-46	68
width	48	68



V6 611022

dimensions	seats	overall
height	40-52	115-139
depth	40-46	68
width	48	68



V6 613022

dimensions	seats	overall
height	40-52	115-139
depth	40-46	68
width	48	68



V6 611050

dimensions	seats	overall
height	40-52	115-139
depth	40-46	68
width	48	68



V6 613050

dimensions	seats	overall
height	40-52	115-139
depth	40-46	68
width	48	68

FABRICS TISSUS

ATLANTIC



ERA

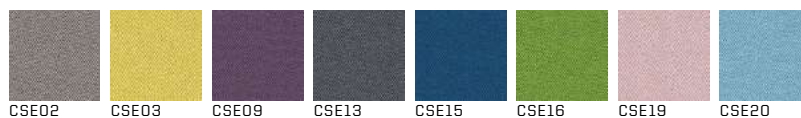

FELICITY

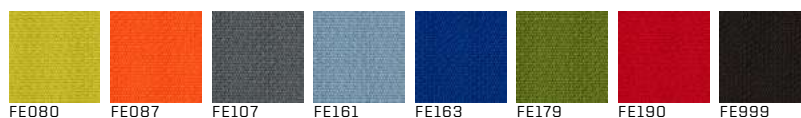

CHARLES



URBAN

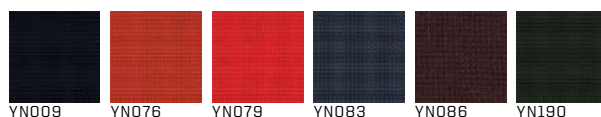

RUNNER

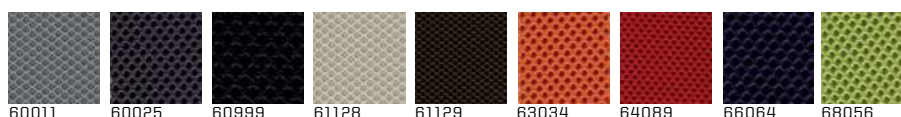

NEXUS

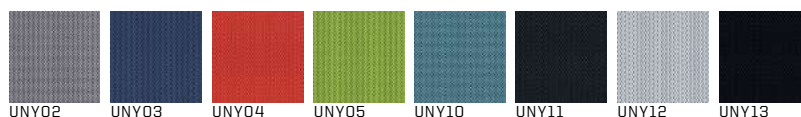

PATINA



SILVERTEX

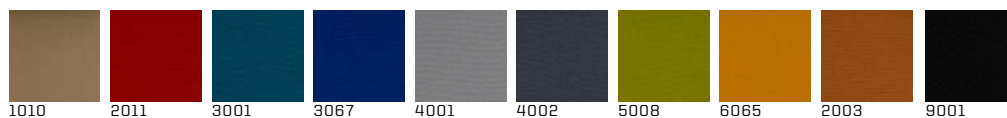

SYNERGY



LEATHER



METAL (BASE AND BACKREST SUPPORTING STRUCTURE) LE MÉTAL (PIÈTEMENT ET LE SUPPORT DU DOSSIER)

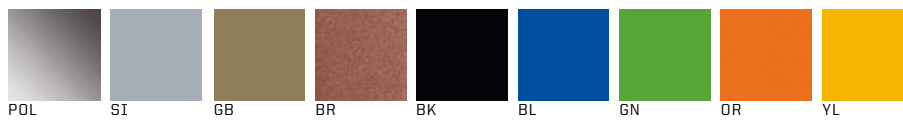

BACKREST MATERIAL LA MATIÈRE DU DOSSIER



ARMREST LA MATIÈRE DU DOSSIER



ARMREST PAD LES COUVERTURES DES ACCOUDOIRS



WHAT THE VANK!

VANK IS A POLISH TEAM OF ARCHITECTS,
CREATIVES, ENGINEERS, AND ARTISANS.
WE CREATE FURNITURE. OBJECTS. TANGIBLE SIGNS
IN SPACE. ITEMS DESIGNED INTELLIGENTLY, WITH
RESPECT FOR THE NATURAL ENVIRONMENT, AND
MANUFACTURED USING LATEST TECHNOLOGIES.

WE BELIEVE IN A CIRCULAR ECONOMY MODEL THAT
LIMITS THE CONSUMPTION OF NATURAL RESOURCES,
REDUCES THE AMOUNT OF WASTE GENERATED,
AND INCREASES THE USE OF BIODEGRADABLE,
RENEWABLE, AND RECYCLABLE MATERIALS.
WE WANT OUR FURNITURE TO IMPROVE THE
AESTHETICS OF THEIR SURROUNDINGS.
TO BE PRESENT AND SEEN WHILE MAINTAINING
THE RIGHT BALANCE BETWEEN FUNCTION AND
VISUAL APPEAL. WE'RE ALL ABOUT HIGH QUALITY,
TAKING RESPONSIBILITY FOR WHAT WE DO AND
MAKE, AND MAKING OUR PRODUCTS LAST
AS LONG AS POSSIBLE.

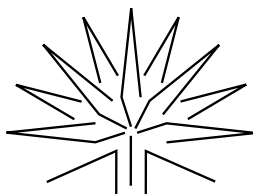

SEE MORE:

WWW.VANK.DESIGN

